

# DB-2610

Flat bed double chain stitcher

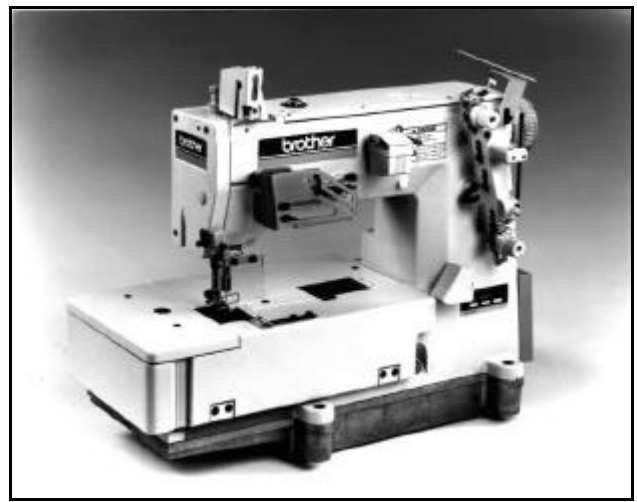

## Specifications

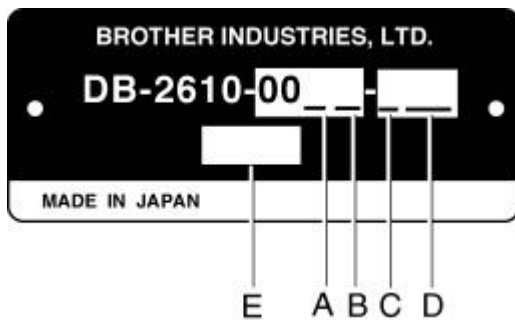













A	Feed type
1	Uniform feed
D	Differential feed
P	Uniform feed + puller







C	No. of needles
1	1 needle
2	2 needles
3	3 needles

E	Devices
	No accessories
RP1	Rear puller device



B	Specifications
1	Single needle, plain stitching (medium-weight materials)
2	Sewing lap seams (medium-weight materials)
3	Sewing lap seams (heavy-weight materials), standard gauge
4	Sewing lap seams (heavy-weight materials), horizontally-stepped gauge (1.9 mm)
5	Sewing lap seams [reverse] (heavy-weight materials), standard gauge
T	Twin needle tandem, plain stitching (medium-weight materials)
D	Needle gauge
M	Attaching pocket facing
00	---
04	0.4 mm
64	6.4 mm
72	7.2 mm
M	Attaching pocket facing 2.5 – 6.4 mm

## Specifications

Sub-class	Application			No. of needle	Needle type (UY128GAS)
0011-100	For plain stitching (Single needle, lower feed, medium-weight materials) * For general sewing of medium-weight materials such as the side of slacks.			1	SCHMETS #80 - #120 ORGAN #12 - #19
0012-264	For sewing lap seams (Twin needle, lower feed, medium-weight materials) * For sewing lap seams of medium-weight materials such as the sides and seats of work clothes.			2	SCHMETS #80 - #120 ORGAN #12 - #19
001T-204	For plain stitching (Tandem needle, lower feed, medium-weight materials) * For general sewing of medium-weight materials in places where extra strength is necessary, such as the seats of slacks.			2	SCHMETS #80 - #120 ORGAN #12 - #19
00D1-100	For plain stitching (Single needle, differential feed, medium-weight materials) * For general sewing of stretch materials such as knitted wear.			1	SCHMETS #80 - #120 ORGAN #12 - #19
0013-264	For sewing lap seams (Twin needle, lower feed, medium to heavy-weight materials)			2	SCHMETS #120 - #140 ORGAN #19 - #22
0013-272	* For sewing crotches in jeans, etc.				
00P3-264	For sewing lap seams (Twin needle, lower feed, medium to heavy-weight materials)			2	SCHMETS #120 - #140 ORGAN #19 - #22
00P3-272	* For sewing crotches in jeans, etc.				
0014-264	For sewing lap seams (Twin needle, lower feed, heavy-weight materials)			2	SCHMETS #120 - #140 ORGAN #19 - #22
0014-272	* For sewing crotches in jeans, etc.				
00P4-264	For sewing lap seams (Twin needle, lower feed, heavy to heavy-weight materials)			2	SCHMETS #120 - #140 ORGAN #19 - #22
00P4-272	* For sewing crotches in jeans, etc.				
0015-264	For sewing lap seams (Reverse) (Twin needle, lower feed, medium to extra heavy-weight materials)			2	SCHMETS #120 - #140 ORGAN #19 - #22
0015-272	* For attaching risers to back panels of jeans, etc.)				
00DM-3M1	For attaching pocket facing to pockets on slacks and jeans (3 rows of double chain stitches with spreader thread, for medium to heavy-weight materials)			3	SCHMETS #80 - #120 ORGAN #12 - #19

Sub-class						
	Needle gauge (mm)	No. of thread	Max. stitch length (mm)	Differential feed ratio	Height of presser foot (mm)	Max. sewing speed (rpm)
0011-100	/	2	3.6	/	10	6,500
0012-264	6.4	4	3.6	/	10	6,000
001T-204	0.4	4	3.6	/	10	6,500
00D1-100	/	2	3.6	0.7 – 1.6 mm	10	6,000
0013-264	6.4	4	4.2	/	10	5,000
0013-272	7.2					
00P3-264	6.4	4	4.5	/	10	4,500
00P3-272	7.2					
0014-264	6.4	4	4.2	/	10	5,000
0014-272	7.2					
00P4-264	6.4	4	4.5	/	10	4,500
00P4-272	7.2					
0015-264	6.4	4	4.2	/	10	5,000
0015-272	7.2					
00DM-3M1	6.4 & 2.5	7	3.6	0.7 – 1.2 mm (for maximum stitch length)	6	5,000

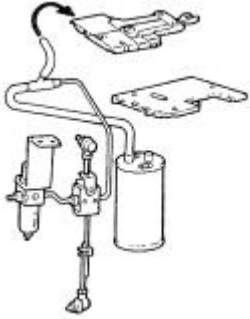
## Optional parts

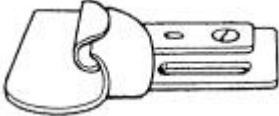
	Part name	Part code	Sub-class
	<CH1> Chain cutter device set (air)	S36510-102	-0011(*1) -0012 -001T -00D1
		S47537-002	-0013 (*2) -0014 (*2) -0015
	Feed dog (for light-weight materials)	S40564-001	-0011
	Lapper 1/4 M assembly (for light-weight materials)	151584-001	-0012

(\*1) When using the DB-2610-0011-100 with a chain cutter installed, set the sewing speed to 6,000 rpm or less.

(\*2) When using the DB-2610-0013 and -0014 with a chain cutter installed, the formation of chaining-off stitches will become more difficult when the standard presser foot assembly is used. Because of this, you should follow the steps in either Solution 1 or Solution 2 as given below.

(Solution 2 is recommended for a more attractive chaining-off stitch formation.)

### <Solution 1>

Adjust the presser foot assembly as given below.

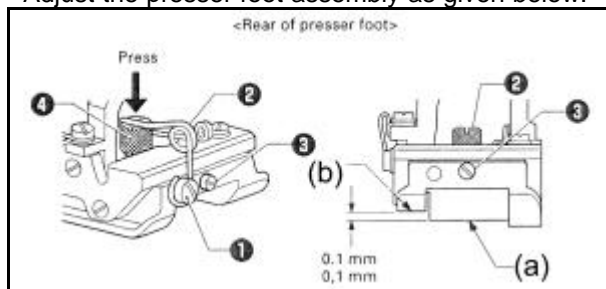



- (1) Remove the Screw ❶ and remove the spring ❷.
- (2) Loosen the set screw ❸.
- (3) While loosening the thumb screw ❹, push it from above until surface (a) is about 0.1 mm below surface (b). Then tighten the set screw ❸.
- (4) Securely tighten the thumb screw ❹.

### <Solution 2>

Use the chaining-off stitch presser foot assembly. Refer to the optional parts table on the next page.

## Optional parts

Part name		Part code	Sub-class
Feeding presser foot (For preventing seam slippage) 	Feeding presser foot set	Feeding presser foot	S40548-301
		Presser bar spring	S18947-001
		Presser bar stopper	S40539-001
		4.37 bolt	154574-001
		4.37 nut	102571-001
		Bolt (×2)	117516-001
		Washer (×2)	100645-003
		Washer (×2)	140407-001
		S49423-001	-0011
Chaining-off stitch presser foot for heavy materials. * This presser foot provides better stitch formation performance for chaining-off stitches. (Recommended when CH1 or CH2 is installed) 	Presser foot 1/4 KF assy. 6.4 mm, flat type	S48638-001	-0013-264
	Presser foot 9/32 KF assy. 7.2 mm, flat type	S48641-001	-0013-272
	Presser foot 1/4 KD assy. 6.4 mm, horizontally stepped (1.9 mm)	S48639-001	-0014-264
	Presser foot 9/32 KD assy. 7.2 mm, horizontally stepped (1.9 mm)	S48642-001	-0014-272
4.8 mm lap seam gauge	3/16 gauge set	Needle clamp 3/16 assy.	S47216-001
		Presser foot 3/16 assy.	S47219-001
		Needle plate 3/16	S47218-001
		Feed dog	S47221-001
	Lapper 3/16 For thin materials	S49420-001	-0012 (*4)
	Lapper 3/16 For medium materials	115834-001	
9.5 mm lap seam gauge (medium materials)	3/8 gauge set	Thread guide, needle bar	115904-001
		Needle clamp 3/8 assy	S45085-001
		Presser foot 3/8 assy	S45090-001
		Needle plate 3/8	S45087-001
		Feed dog	S45092-001
		Rear needle guard H (*5)	S40985-201
		Front needle guard 3/8	S45089-001
		Front cover	S47181-001
		Sub-front cover	S47182-001
		Screw, flat SM 3.57 (×2)	108960-002
		Sub-cloth plate	S44876-001
	Lapper 3/8 MH assy	S37818-001	-0012 (*4)

(\*4) If changing the specifications based on specifications for other models, refer to the parts book for details on which parts need to be replaced.

(\*5) For sewing machines which have the new type of rear needle guard H installed, it is not necessary to replace rear needle guard H.

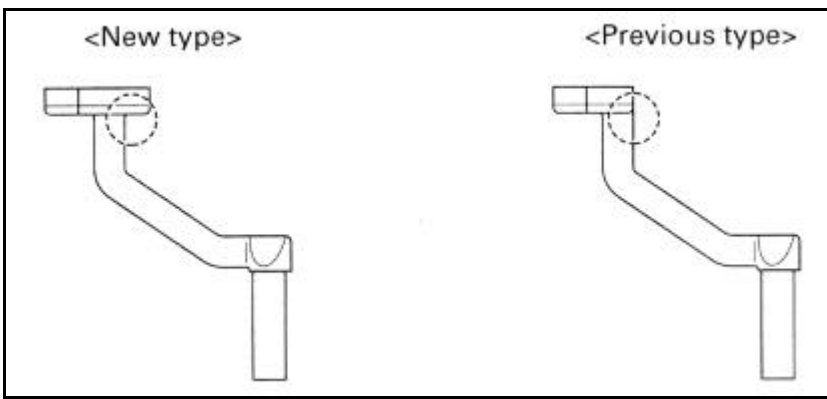

\*The puller cannot be attached separately, so it is not available as an optional part.

## Synchronizer

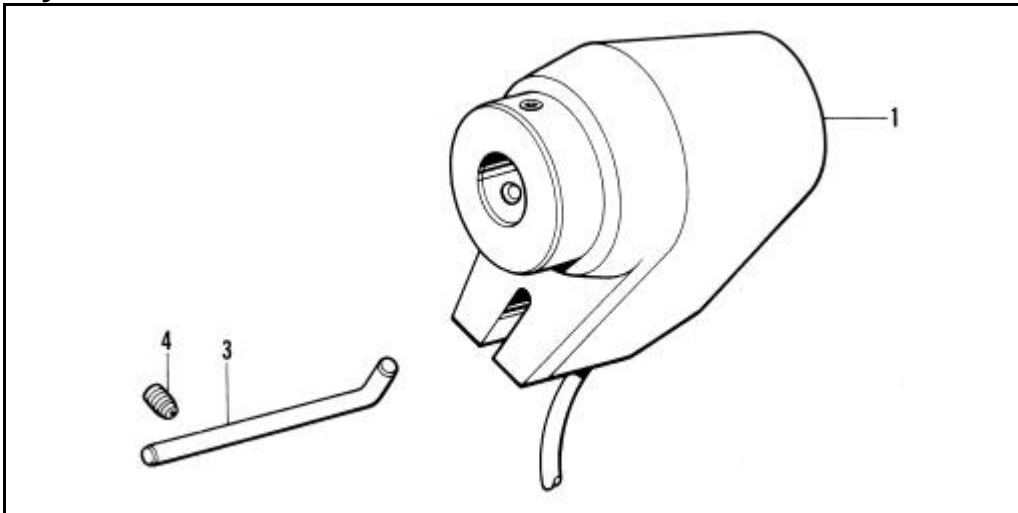

Ref. No.	Part name	Part code	Q'ty
1	Synchronizer #17-2	J80347-001	1
3	Synchronizer guide	S28963-001	1
4	Set screw, socket (CP) SM4.37	014680-622	1

\* When using the synchronizer, use the motor and V belt listed below.

### Motor

Single-phase	MD-621
3-phase	MD-631

### V-belt

V-belt	M 38
--------	------



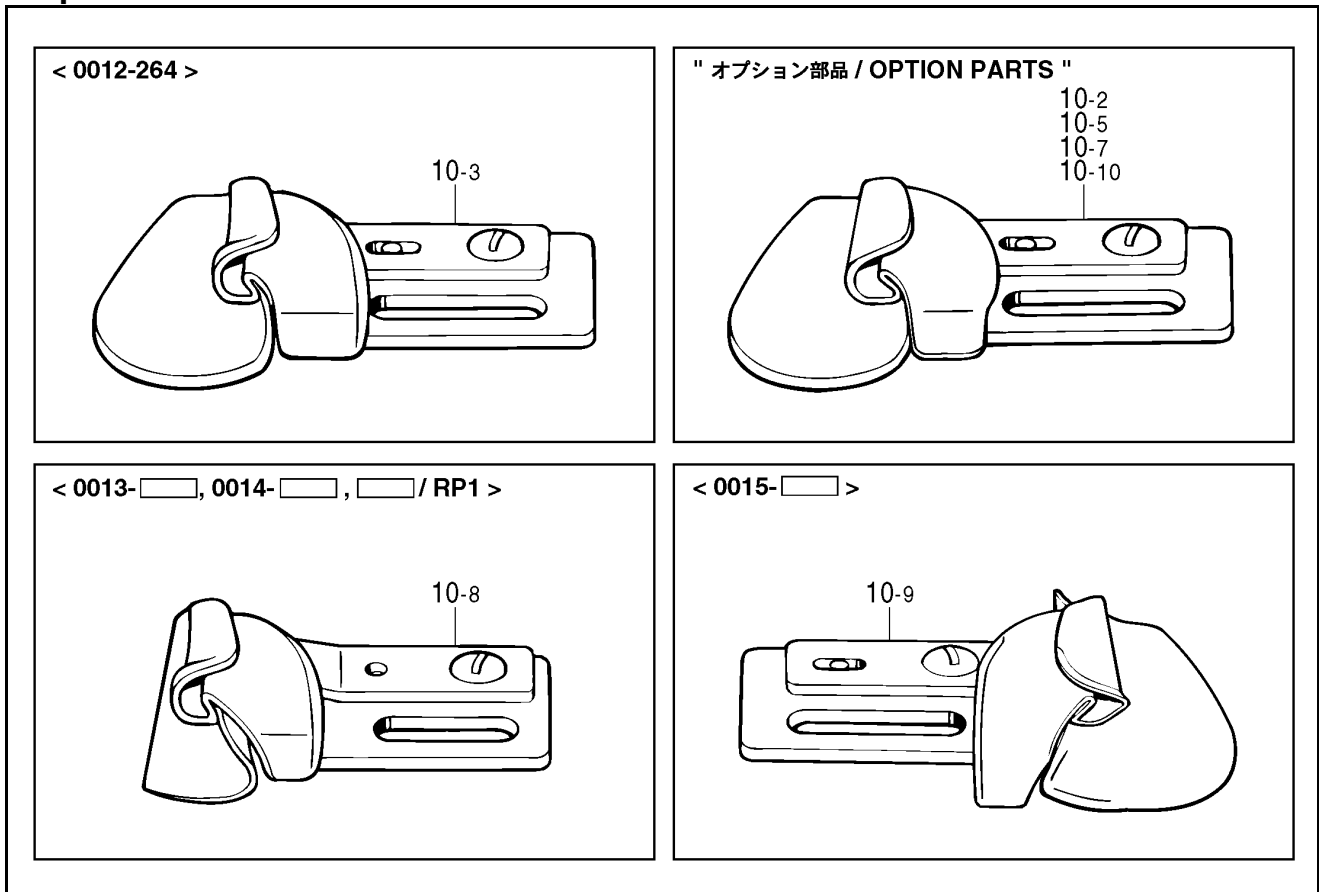



## Lap seam folders



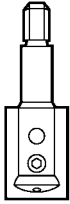
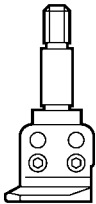
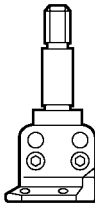
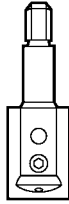
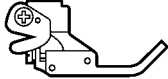
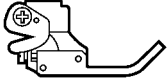
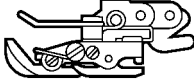
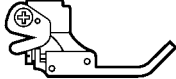

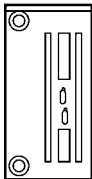
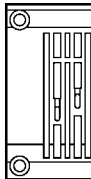
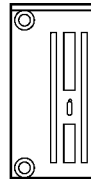
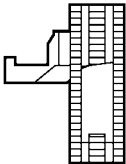
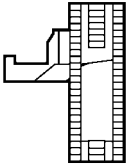
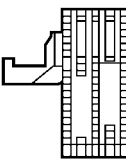

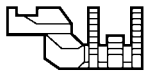
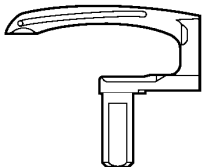
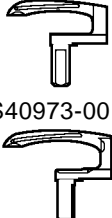
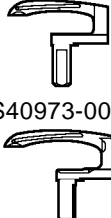
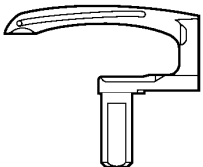
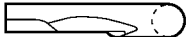
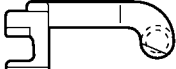
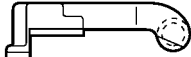

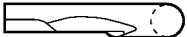



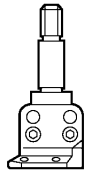
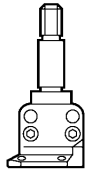
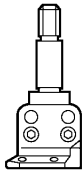
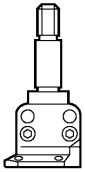
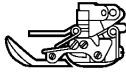

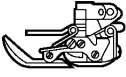
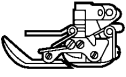
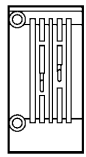
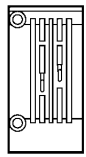
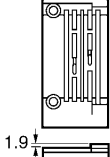
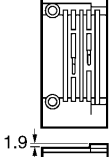
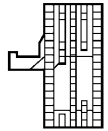
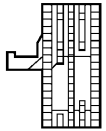
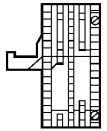
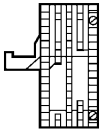





Ref. No.	Part name	Part code
	<b>&lt;0012-264 &gt;</b>	
10-3	Lapper 1/4" assy	113880-001
	<b>&lt;0013-***, 0014***, ***/RP1&gt;</b>	
10-8	Lapper 1/4" XHassy	S44912-000
	<b>&lt;0015-***&gt;</b>	
10-9	Lapper 1/4" XHG assy	S48630-001
	<b>&lt;Option parts&gt;</b>	
	<b>(Medium-weight materials 4.8 gauge)</b>	
10-2	Lapper 3/16" assembly	115834-001
	<b>(Light-weight materials 6.4 gauge)</b>	
10-5	Lapper 1/4" M assy	151584-001
	<b>(Medium-heavy materials 9.5 gauge)</b>	
10-7	Lapper 3/8" MH assy	S37818-001
	<b>(Light-weight materials 4.8 gauge)</b>	
10-10	Lapper 3/16" M assy	S49420-001

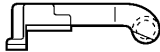

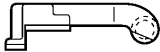









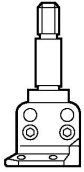
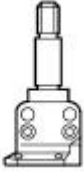

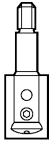
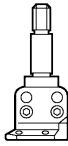

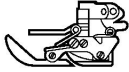

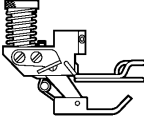

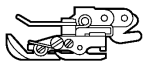
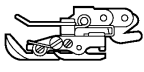
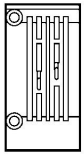
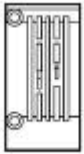
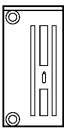
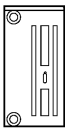
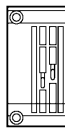
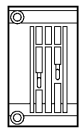
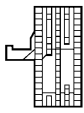
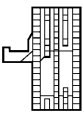
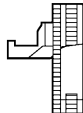
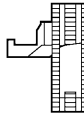
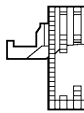
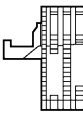





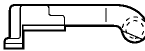

# GAUGE PARTS LIST

Specifications	0011-100	001T-204	0012-264	00D1-100
Label	S28933-003	S28933-004	S28933-005	S28933-006
Application	Plain stitching	Plain stitching	Binding stitching	Plain stitching
No. of needles	1	2	2	1
Needle spacing (mm)	-	0.4	6.4	-
Needle clamp assembly	 S17480-201	 S40962-001	 S40987-101	 S17480-201
Presser foot assembly	 S40541-101	 S40969-101	 S40990-201	 S40952-101
Needle plate	 S40538-001	 S40964-001	 S40989-001	 S40538-001
Feed dog	 S40565-001	 S40972-001	 S40995-001	 S40954-001  S40955-001
Looper	 S40569-001	 S40973-001 S40974-001	 S40973-001 S40974-001	 S40569-001
Needle guard	 S08756-001	 S40967-001	 S40985-201  S40986-101	 S08756-001



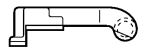
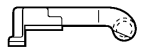







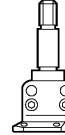
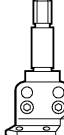
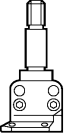
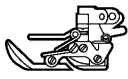
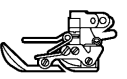

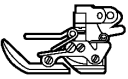

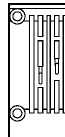
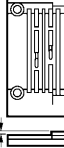
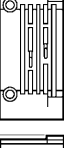
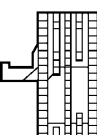
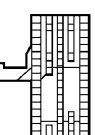
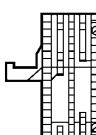
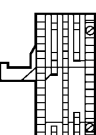

# GAUGE PARTS LIST

Specifications	0013-264	0013-272	0014-264	0014-272
Label	S28933-008	S28933-009	S28933-010	S28933-011
Application	Heavy materials	Heavy materials	Heavy materials	Heavy materials
No. of needles	2	2	2	2
Needle spacing (mm)	6.4	7.2	6.4	7.2
Needle clamp assembly	 S40987-101	 S44880-001	 S40987-101	 S44880-001
Presser foot assembly	 S44888-001	 S44892-001	 S44891-001	 S44894-001
Needle plate	 S44883-001	 S44885-001	 S44884-001	 S44886-001
Feed dog	 S44904-001	 S44904-001	 S44901-001	 S44901-001
Looper	 S40973-001  S40974-001	 S40973-001  S40974-001	 S40973-001  S40974-001	 S40973-001  S40974-001
Needle guard	 S40985-201  S40986-101	 S40985-201  S40986-101	 S40985-201  S40986-101	 S40985-201  S40986-101

# GAUGE PARTS LIST

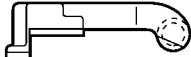
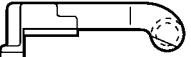
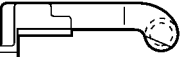
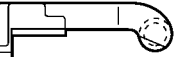
Specifications	0015-264	0015-272	for 0011-100	for 0011-100	for 0012-264	for 0012-264
Label	S28933-013	S28933-014	Option	Option	Option	Option
Application	Heavy materials	Heavy materials	Plain stitching (Thin W / feeding presser foot)	Plain stitching (Medium thick W / feeding presser foot)	Binding stitching	Binding stitching
No. of needles	2	2	1	1	2	2
Needle spacing (mm)	6.4	7.2	-	-	4.8	9.5
Needle clamp assembly	 S40987-101	 S44880-001	 S17480-201	 S17480-201	 S47216-001	 S45085-001
Presser foot assembly	 S48633-001	 S48636-001	 S40548-301	 S40548-301	 S47219-001	 S45090-001
Needle plate	 S44883-001	 S44885-001	 S40538-001	 S40538-001	 S47218-001	 S45087-001
Feed dog	 S44904-001	 S44904-001	 S40564-001 (Extra fine feed dog)	 S40565-001	 S47221-001	 S45092-001
Looper	 S40973-001	 S40973-001	 S40569-001	 S40569-001	 S40973-001	 S40973-001
	 S40974-001	 S40974-001			 S40974-001	 S40974-001
Needle guard	 S40985-201	 S40985-201	 S08756-001	 S08756-001	 S40985-201	 S40985-201
	 S40986-101	 S40986-101			 S40986-101	 S45089-001

# GAUGE PARTS LIST

Specifications	for 0013-264	for 013-272	for 0014-264	for 0014-272
Label	Option	Option	Option	Option
Application	Heavy materials (for chaining-off stitches)	Heavy materials (for chaining-off stitches)	Heavy materials (for chaining-off stitches)	Heavy materials (for chaining-off stitches)
No. of needles	2	2	2	2
Needle spacing (mm)	6.4	7.2	6.4	7.2
Needle clamp assembly	 S40987-101	 S44880-001	 S40987-101	 S44880-001
Presser foot assembly	 S48638-001	 S48641-001	 S48639-001	 S48642-001
Needle plate	 S44883-001	 S44885-001	 S44884-001	 S44886-001
Feed dog	 S44904-001	 S44904-001	 S44901-001	 S44901-001
Looper	 S40973-001	 S40973-001	 S40973-001	 S40973-001
	 S40974-001	 S40974-001	 S40974-001	 S40974-001
Needle guard	 S40985-201	 S40985-201	 S40985-201	 S40985-201
	 S40986-101	 S40986-101	 S40986-101	 S40986-101